

MYERS[®]
CENTRI-THRIFT
CENTRIFUGAL PUMPS

MYERS® CENTRI-THRIFT

Built for Continuous, Trouble Free Service

Continuous service pumps must be rugged and reliable. Over the years, MYERS Centri-Thrift pumps have earned a reputation for dependable and efficient performance in demanding continuous service applications.

The Centri-Thrift line is available in 1 1/4", 1 1/2", and 2" discharge sizes. Horsepower requirements range from 2 HP to 7 1/2 HP.

Capacities range to 240 gpm and heads to 140 feet. The pumps are available only as standard fitted, and can be either close-coupled or belt driven.

For added versatility, the volute on the 125M, 150M and 200M series can be rotated to eight positions at 45° intervals. These adjustments allow for ease of installation and servicing without disturbing the system's piping.

APPLICATIONS

- Booster Service
- Air Conditioning
- Cooling Towers
- Refrigeration
- Cold and Hot Water Circulation
- Liquid Transfer
- Sprinkling
- Laundry Equipment
- Irrigation
- Building Service
- Spraying Equipment
- General Industrial Service

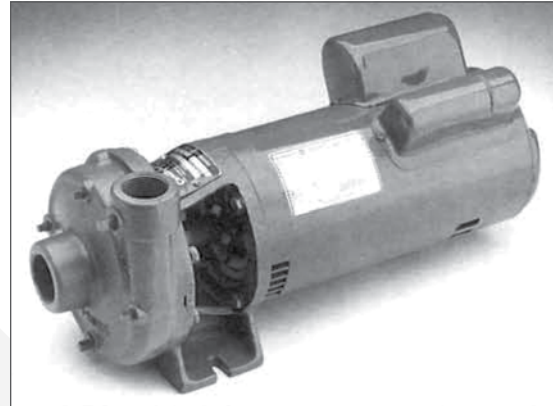

125M

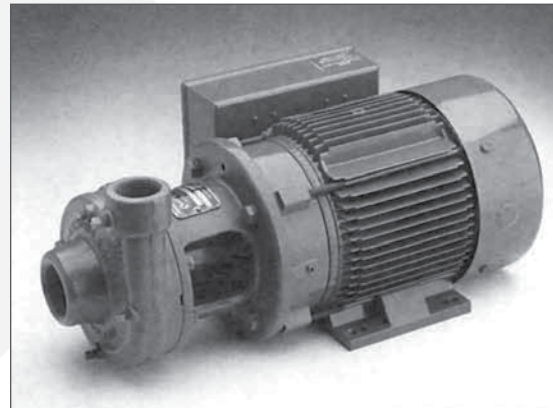

150M

PERFORMANCE CHART

(For proper pump selection, refer to individual pump performance curve.)

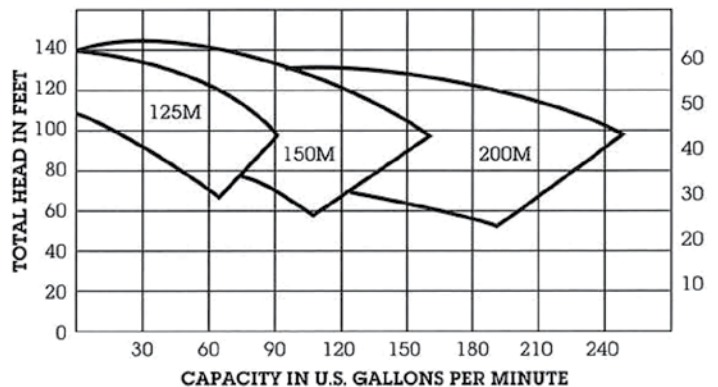

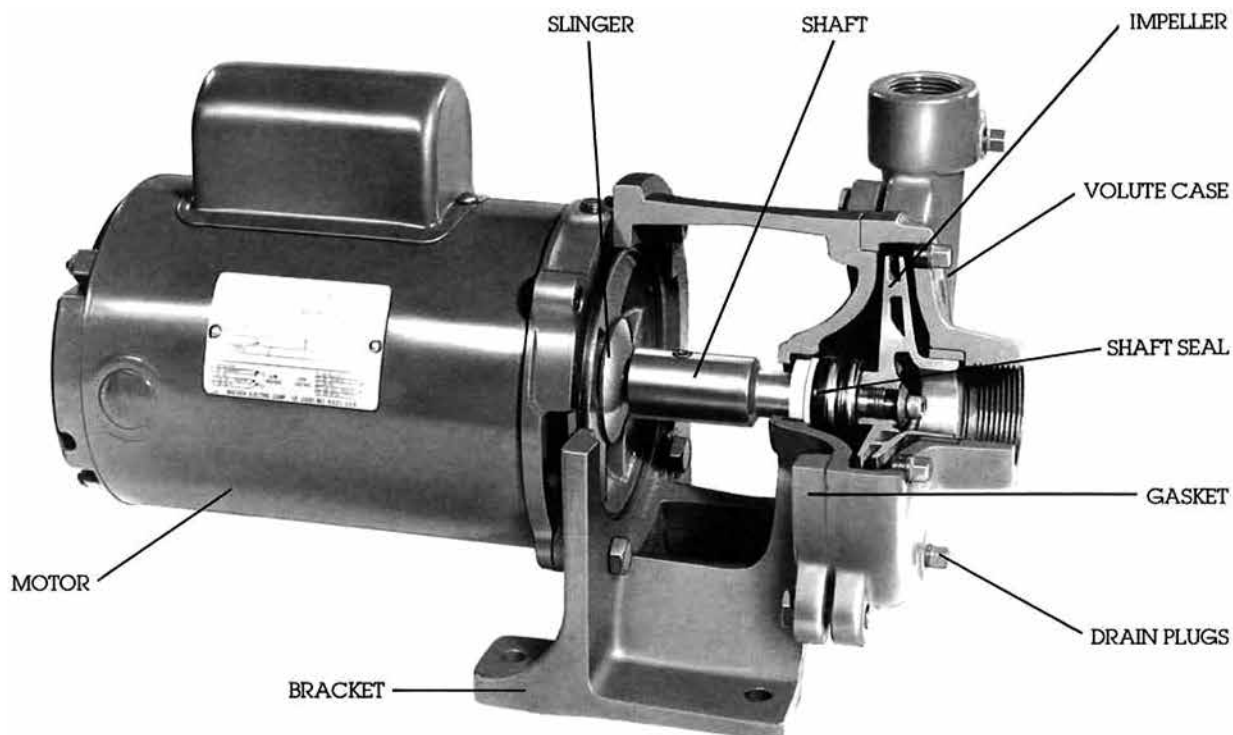

CONSTRUCTION MATERIALS

SHAFT SEAL

Mechanical seal features a ceramic seat, carbon washer, stainless steel spring, brass metal parts and a synthetic rubber bellows. Suitable for temperatures up to 140°F. All seals are self-adjusting and easily replaced. For special seals, please consult factory.

VOLUTE CASE

High tensile gray iron with threaded suction and discharge connections.

BRACKET

High tensile gray iron. Provides mount for motor and volute case.

GASKET

Field proven material resistant to most liquids. Provides a seal between the volute case and bracket.

IMPELLER

Bronze, closed one piece design, dynamically balanced to prevent vibration. Attached with a key and stainless steel capscrew to prevent backoff.

SHAFT

Stainless steel stub shaft couples motor and pump together. This corrosion resistant shaft provides perfect alignment for quiet, troublefree operation.

SLINGER

Rubber slinger ring protects motor from moisture damage.

DRAIN PLUGS

Are located in four positions to allow easy draining of the pump case in any position.

MOTOR

Standard NEMA C Face, open drip-proof, end mounted, 3600 RPM, 60 Hz. Single or three phase in 2 to 5 HP range and three phase for the 7 1/2 HP size. Single phase are available in 115/230 volts and three phase in 230/460 volts. All motors are matched to their individual impeller to prevent overloading.

BALL BEARINGS

(not illustrated) - For belt driven pumps. The 125B, 150B and 200B bearings are easily relubricated.

DIMENSIONS (For estimating only)

125M- 150M- 200M SERIES 2 and 3 HP

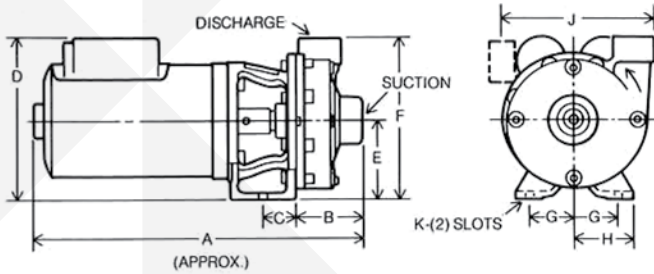

Model	HP	Phase	Discharge	Suction	DIMENSIONS, INCHES										
					A	B	C	D	E	F	G	H	J	K	
125M	2	1	1 1/4"	1 1/2"	18 5/8	3 13/16	1 13/16	9 3/4	4 1/2	9 3/16	2 1/2	3 5/16	8 1/4	1/2	
	2	3	1 1/4"	1 1/2"	18 1/16	3 13/16	1 13/16	7 3/4	4 1/2	9 3/16	2 1/2	3 5/16	8 1/4	1/2	
	3	1	1 1/4"	1 1/2"	19 15/16	3 13/16	1 13/16	9 3/4	4 1/2	9 3/16	2 1/2	3 5/16	8 1/4	1/2	
	3	3	1 1/4"	1 1/2"	18 11/16	3 13/16	1 13/16	7 3/4	4 1/2	9 3/16	2 1/2	3 5/16	8 1/4	1/2	
150M	2	1	1 1/2"	2"	18 15/16	4 1/8	1 13/16	9 3/4	4 1/2	9 3/16	2 1/2	3 5/16	8 7/16	1/2	
	2	3	1 1/2"	2"	18 3/8	4 1/8	1 13/16	7 3/4	4 1/2	9 3/16	2 1/2	3 5/16	8 7/16	1/2	
	3	1	1 1/2"	2"	20 1/4	4 1/8	1 13/16	9 3/4	4 1/2	9 3/16	2 1/2	3 5/16	8 7/16	1/2	
	3	3	1 1/2"	2"	19	4 1/8	1 13/16	7 3/4	4 1/2	9 3/16	2 1/2	3 5/16	8 7/16	1/2	
200M	3	1	2"	2 1/2"	20 3/4	4 5/8	1 13/16	9 3/4	4 1/2	9 7/16	2 1/2	3 5/16	9 3/16	1/2	
	3	3	2"	2 1/2"	19 3/4	4 5/8	1 13/16	7 3/4	4 1/2	9 7/16	2 1/2	3 5/16	9 3/16	1/2	

150M- 200M SERIES 5 and 7 1/2 HP

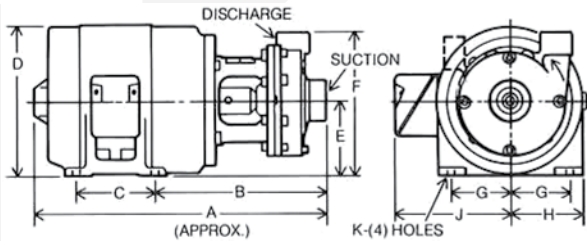

Model	HP	Phase	Discharge	Suction	DIMENSIONS, INCHES										
					A	B	C	D	E	F	G	H	J	K	
150M	5	1	1 1/2"	2"	21 13/16	11 11/16	5 1/2	9 3/16	4 1/2	9 3/4	3 3/4	4 1/2	8 1/2	13/32	
	5	3	1 1/2"	2"	19 15/16	11 11/16	4 1/2	9 3/16	4 1/2	9 3/4	3 3/4	4 1/2	7	13/32	
200M	5	1	2"	2 1/2"	22 5/16	12 13/16	5 1/2	9 3/16	4 1/2	9 7/16	3 3/4	4 1/2	8 1/2	13/32	
	5	3	2"	2 1/2"	21 7/16	12 13/16	4 1/2	9 3/16	4 1/2	9 7/16	3 3/4	4 1/2	7	13/32	
	7 1/2	3	2"	2 1/2"	22 1/16	12 13/16	5 1/2	9 3/16	4 1/2	9 7/16	3 3/4	4 1/2	7	13/32	

125B-150B-200B BELT DRIVEN SERIES

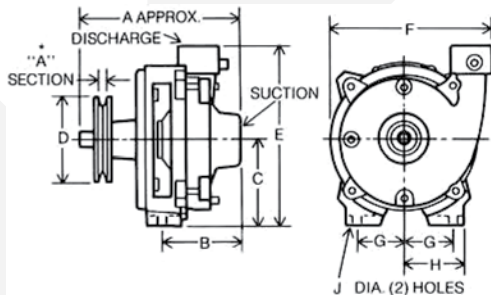

Model	Discharge	Suction	DIMENSIONS, INCHES									
			A	B	C	D*	E	F	G	H	J	Dia. Shaft for Pulley
125B	1 1/4"	1 1/2"	16	3 13/16	4 1/2	4 1/2	9 3/16	8 9/32	2 1/2	3 9/32	7/16	7/8
150B	1 1/2"	2"	16 5/16	5 27/32	4 1/2	4 1/2	9 3/4	8 7/16	2 1/2	3 9/32	7/16	7/8
200B	2"	2 1/2"	16 13/16	6 7/16	4 1/2	4 1/2	9 7/16	9 3/16	2 1/2	3 9/32	7/16	7/8

* Pulleys not included



740 EAST 9TH STREET,
ASHLAND, OHIO 44805
WWW.FEMYERS.COM

490 PINEBUSH ROAD, UNIT 4,
CAMBRIDGE, ONTARIO
N1T 0A5
WWW.FEMYERS.COM

Because we are continuously improving our products and services, Pentair reserves the right to change specifications without prior notice.
K3150 12/06/13 © 2013 Pentair. All Rights Reserved.